

2.4 Formulate Straight Fabric Display Mk 2

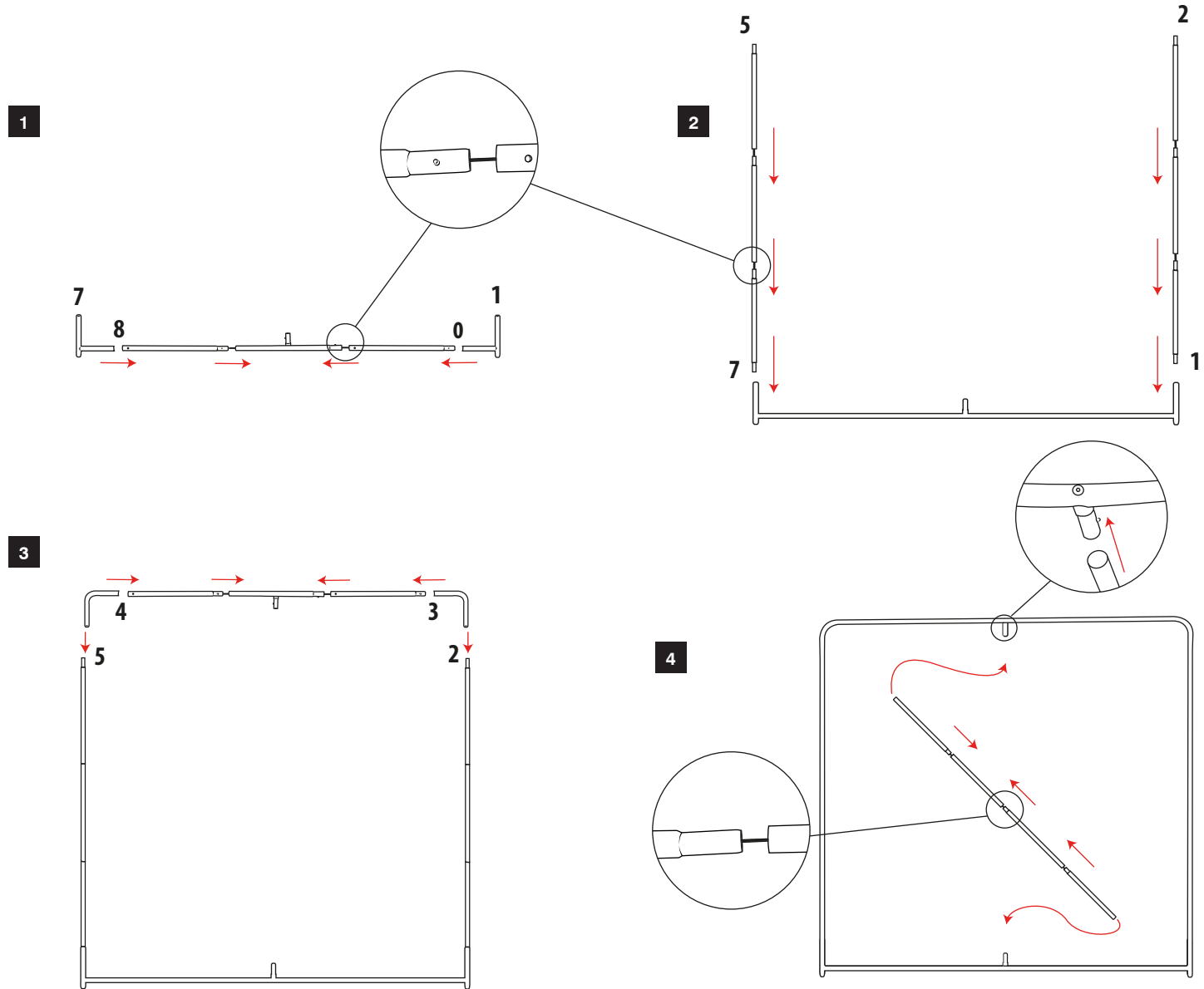
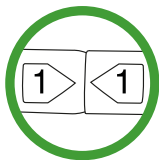
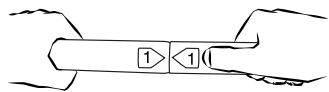
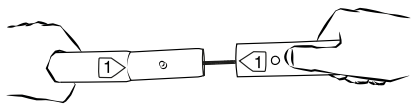
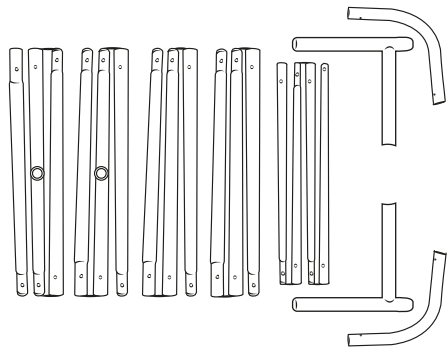

NOTE: CONNECTION NUMBER "6" INTENTIONALLY OMITTED

2.4m Formulate Straight Fabric Display Mk 2

Attaching Graphic

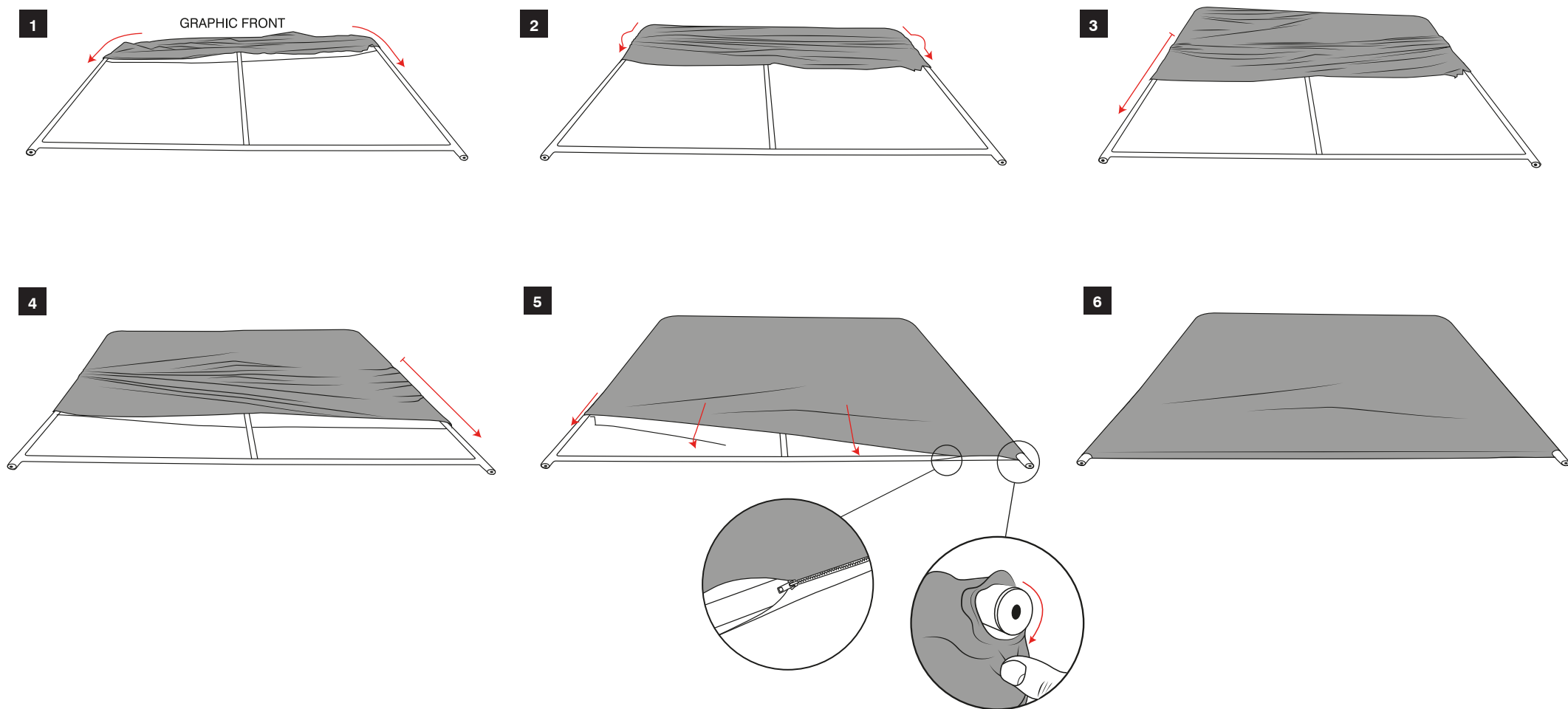

2.4m Formulate Straight Fabric Display Mk 2

Attaching Feet

1

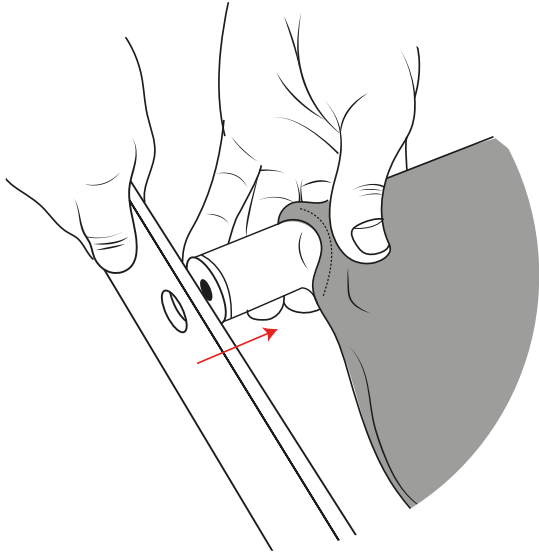

2

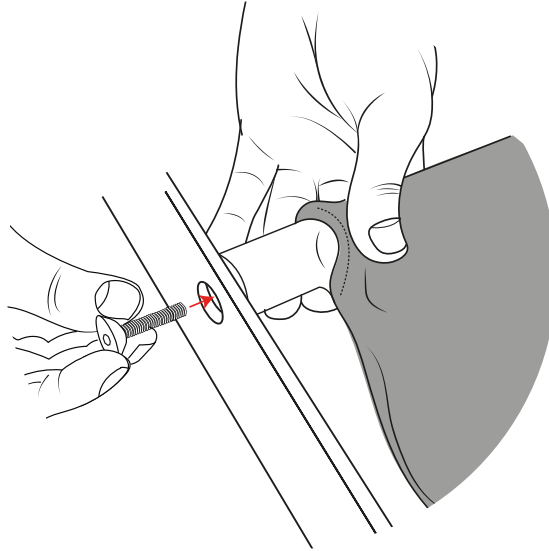

3

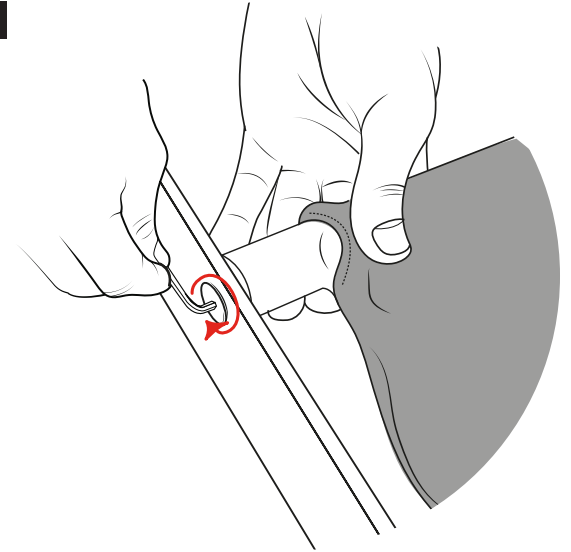

4

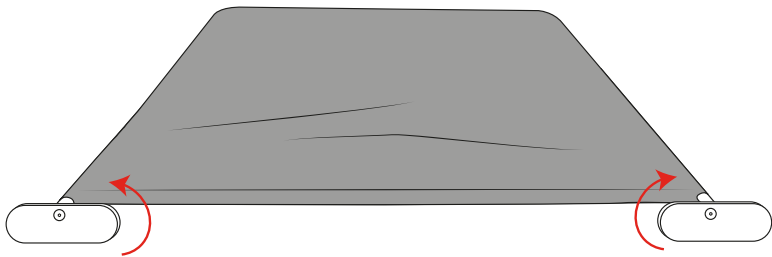

5

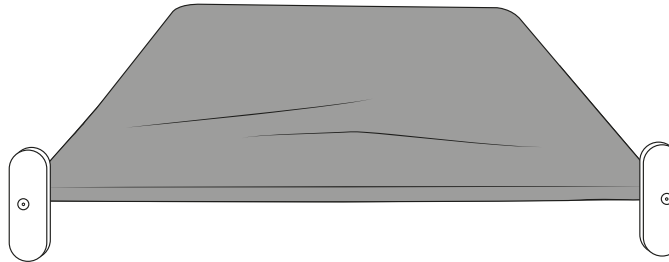

6

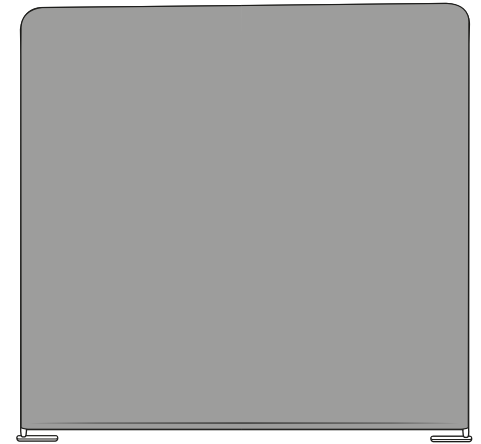

3m Formulate Straight Fabric Display Mk 2

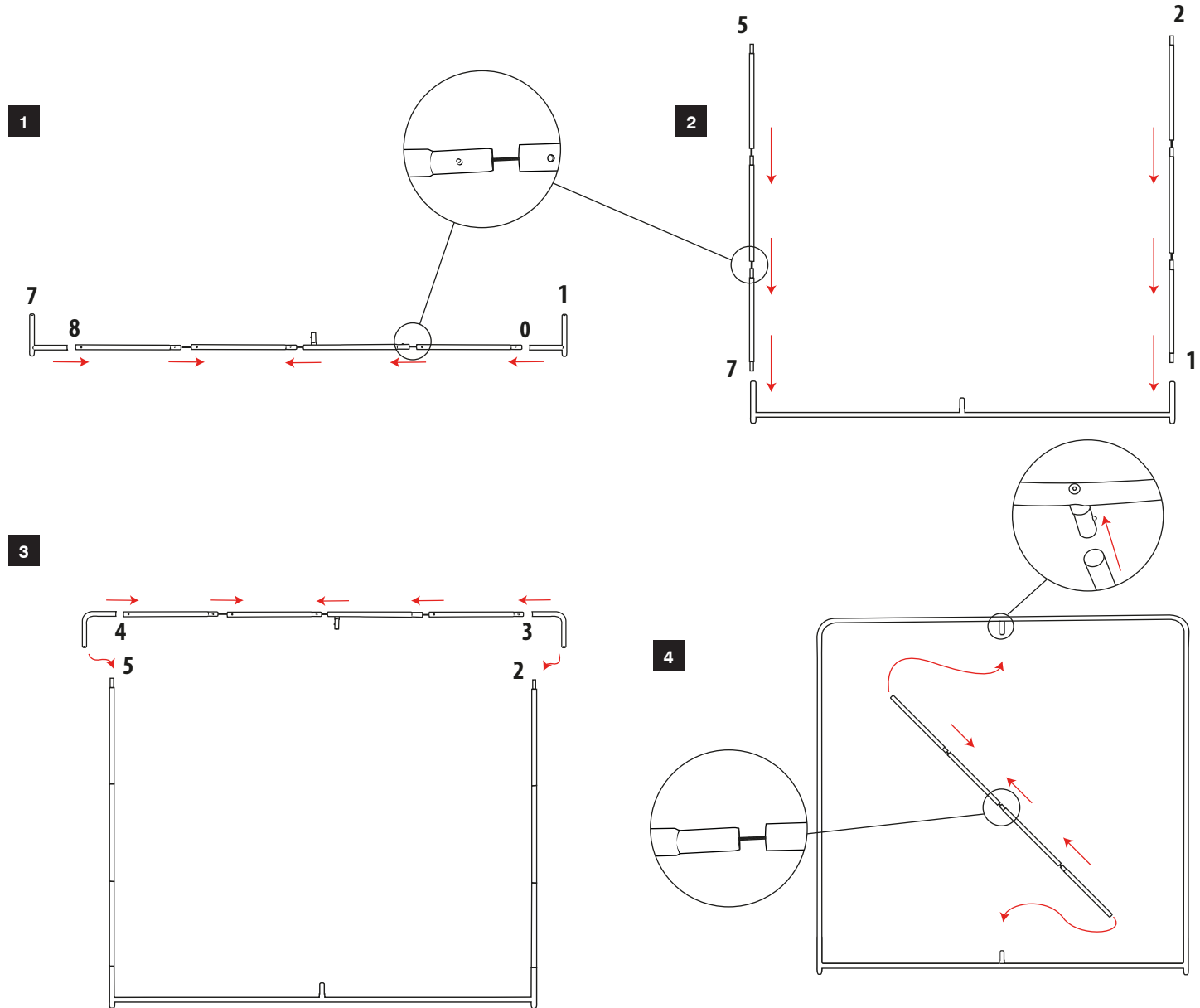
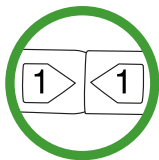
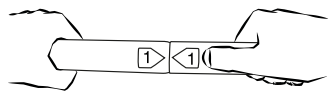
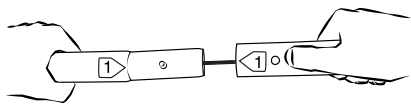
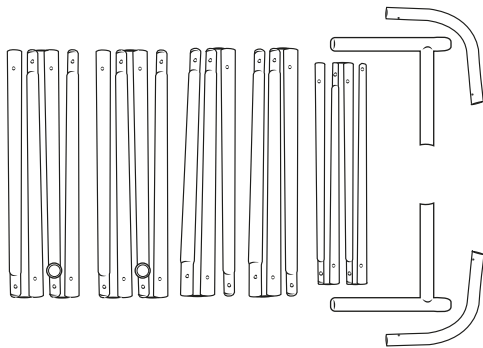

NOTE: CONNECTION NUMBER "6" INTENTIONALLY OMITTED

3m Formulate Straight Fabric Display Mk 2

Attaching Graphic

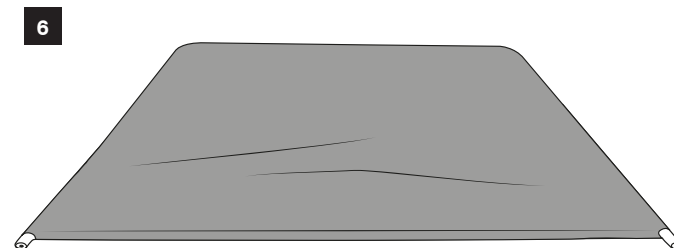
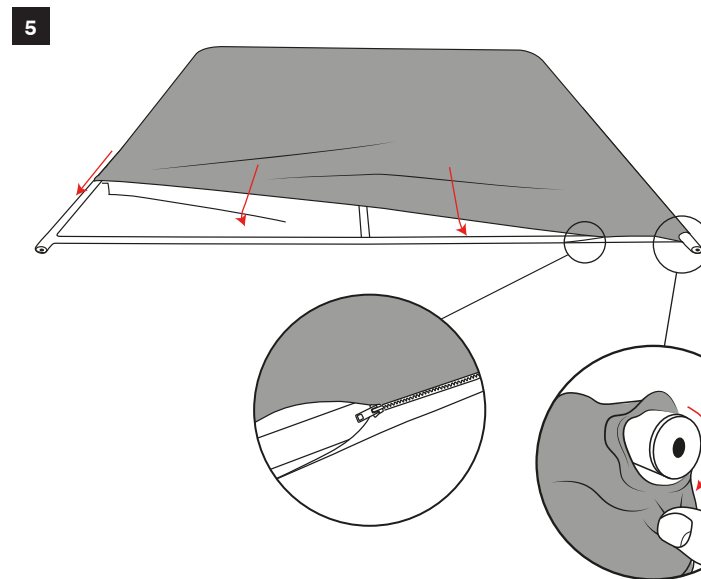
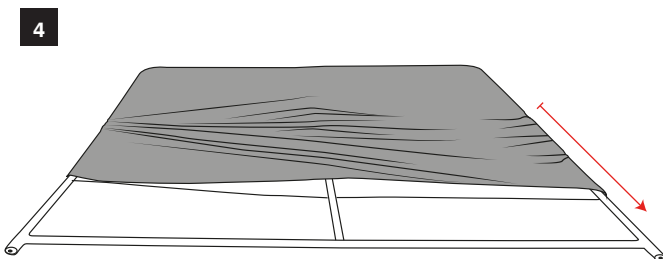
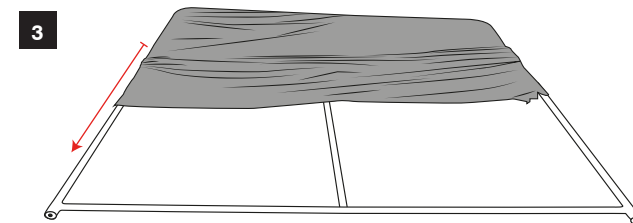
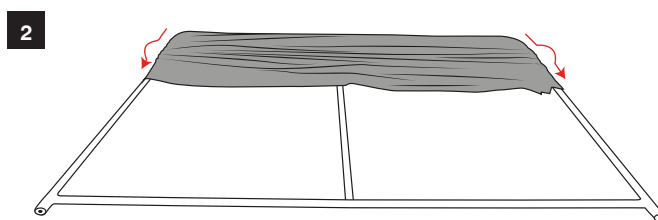
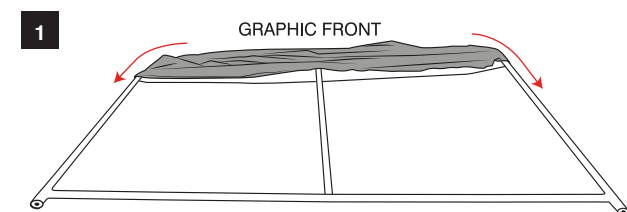

3m Formulate Straight Fabric Display Mk 2

Attaching Feet

1

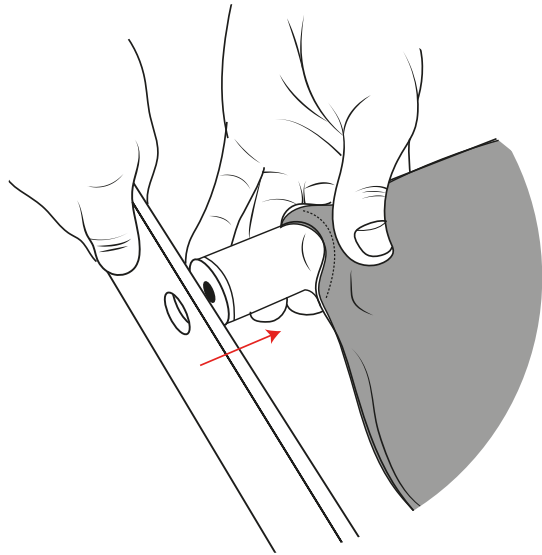

2

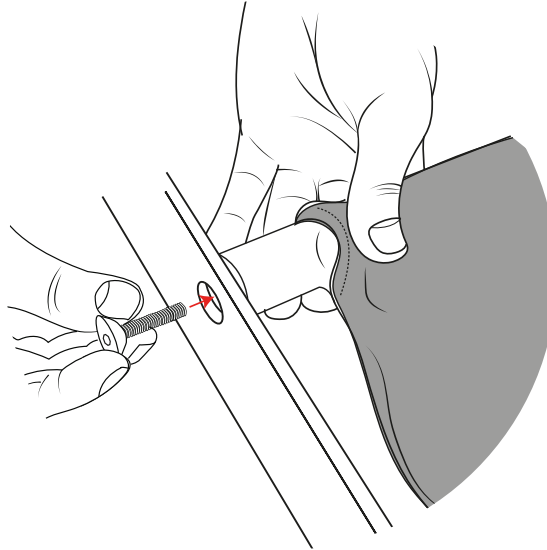

3

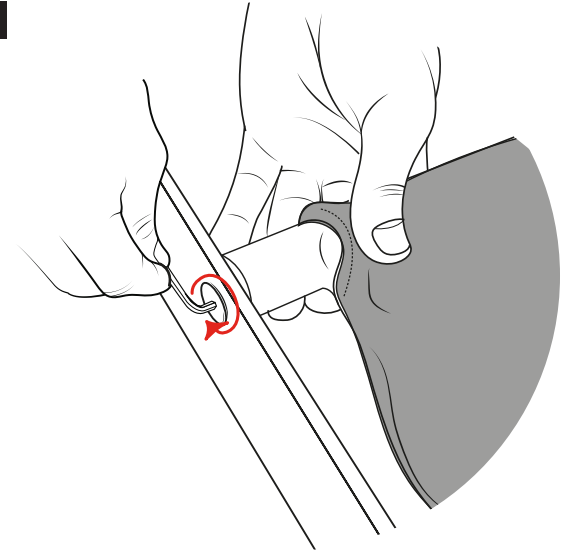

4

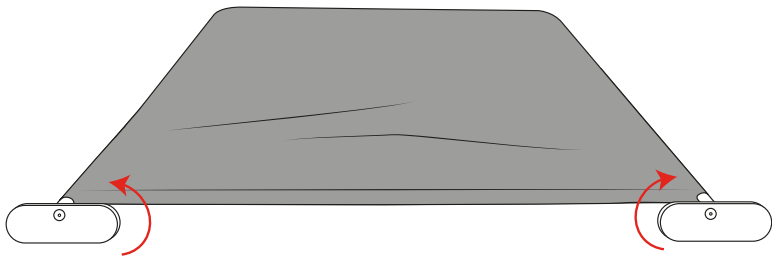

5

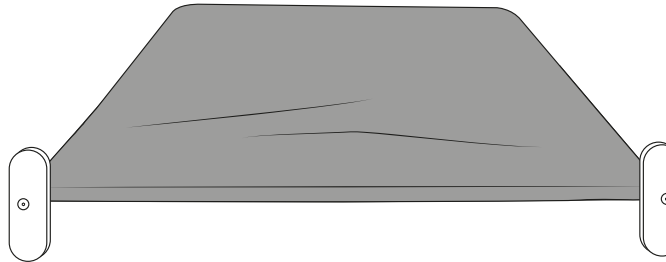

6

